

Dental Chair

PRO II

037/039



 Belmont®

PRO II 037/039

039 AXIS POWER HEADREST

moves smoothly due to its axis mechanism which simulates rotation of patient's neck, and patient can comfortably keep mouth open and provides dentist with an improved view of oral cavity.

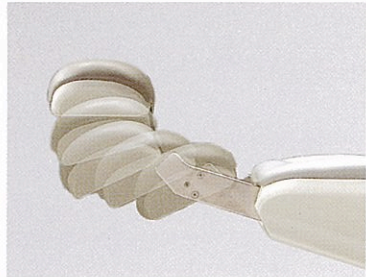

(OPTIONAL FEATURE FOR 037)
TWIN AXIS ARTICULATING HEADREST
is reversible and suitable for both children and adults.

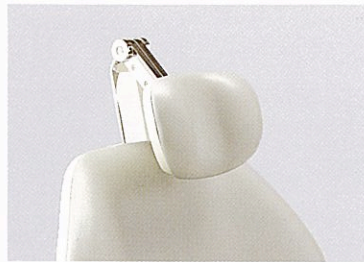

SWING-OUT ARMREST
for easy entry and exit for patient.

LUMBER SUPPORT
is anatomically correct in all positions.

UPHOLSTERY
Easy to clean, seamless upholstery.
Flame retardant.
A choice from 11 colours.



037 OFFSET ARTICULATING HEADREST

provides occipital support and proper angulation for viewing oral cavity.

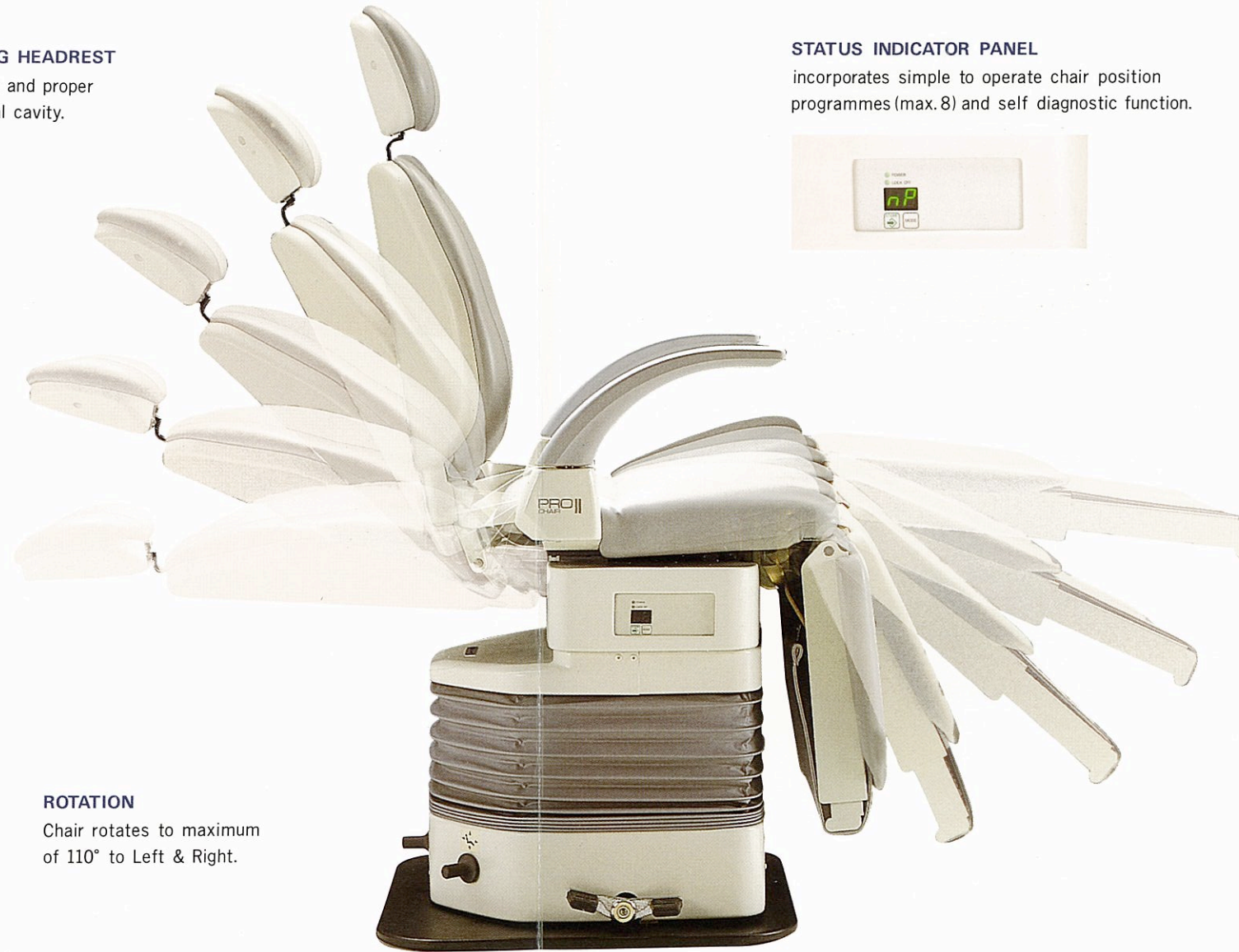

ROTATION
Chair rotates to maximum of 110° to Left & Right.

FOOT CONTROLS
allow operator to position patient quickly and correctly leaving hands free and clean.



- ① LOCK PEDAL
- ② MANUAL (BACK & BASE MOVEMENTS)
- ③ AUTO-RETURN/2 PRESETS/LAST POSITION MEMORY
- ④ MANUAL (BACK & BASE MOVEMENTS)

PRO II CHAIR FEATURES A FOLDING LEGREST WHICH PROVIDES EASY ENTRY AND EXIT.
This unique design creates an ideal environment for personal consultation and communication between dentist and patient.

HANDS-FREE OPERATION PERMITS EFFECTIVE INFECTION CONTROL.

3 preset positions, back and base movements are operated by foot lever.

Dentist, staff, and patient are protected from disease transmission from finger-to-switch contamination.

Eye to oral cavity contact can be maintained during procedure.

THE SYNCHRONOUS MOVEMENT OF BACKREST AND SEAT PERFECTLY FITS PATIENT'S BODY.

STATUS INDICATOR PANEL
incorporates simple to operate chair position programmes (max. 8) and self diagnostic function.



ROLL-UP LEGREST
extends when chair is in a preset position and retracts when chair is in a consultation position or entry/exit position.

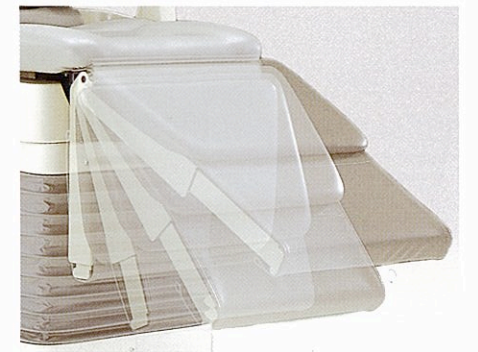

**039
FOOT SWITCH FOR HEADREST**
Hands-free operation of power headrest eliminates risk of cross contamination from hand-to-headrest contact.



PRO II

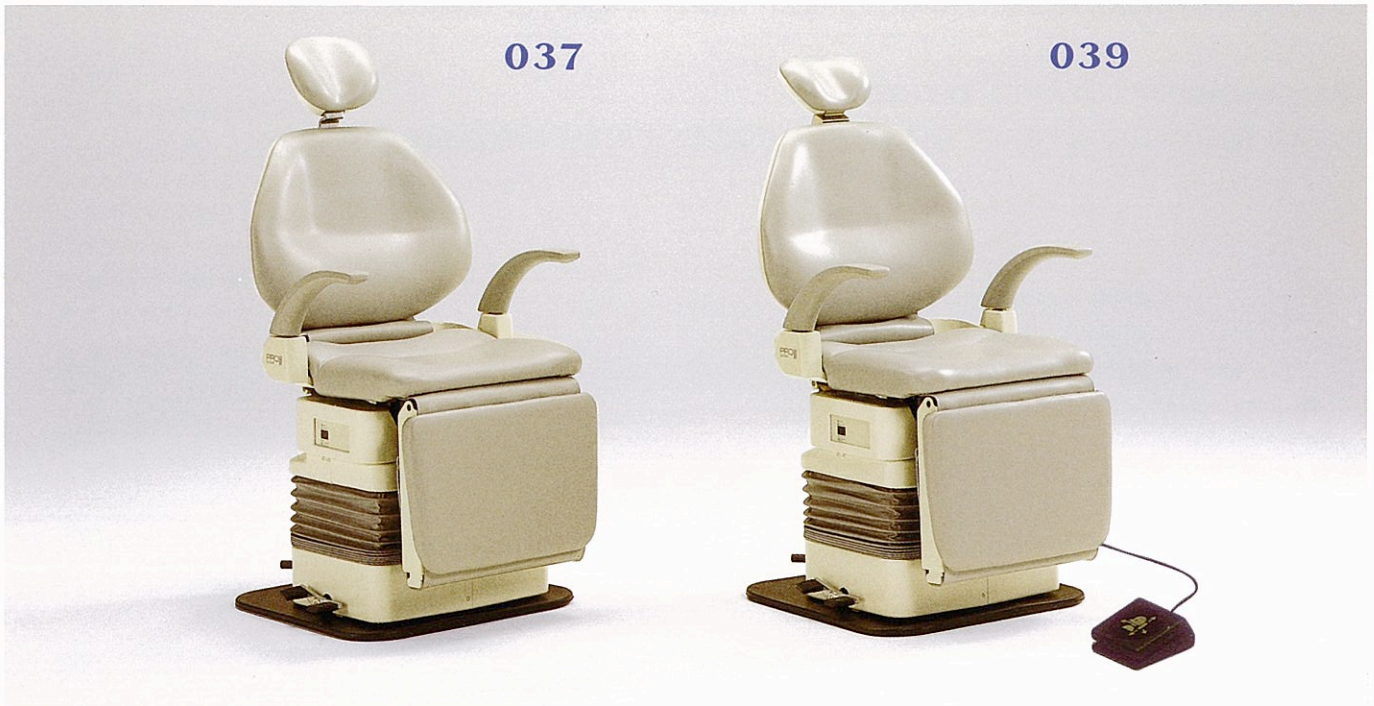

Dimensions/Specifications

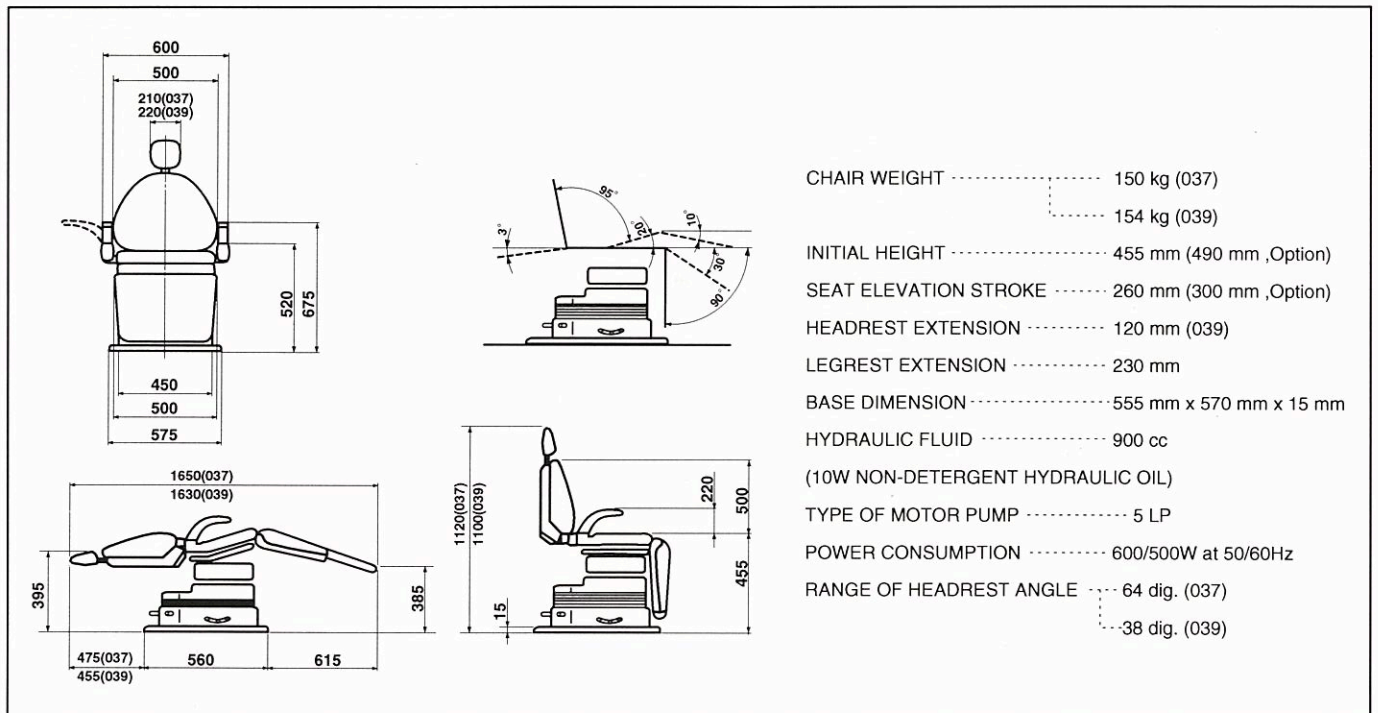

The manufacturers reserve the right to alter and improve the specification without notice.